



**A54B1Y11**

<b>Product</b>	Rocker Switch
<b>Serial</b>	A54 Series
<b>Connection / Nominal Dimension</b>	30*22mm
<b>Body Color</b>	Black Body
<b>Contact</b>	2NO
<b>Illumination</b>	with Illumination
<b>Connection Type</b>	with Terminal
<b>Print</b>	(0-I) Marked
<b>Color</b>	Green
<b>Current</b>	<b>Ie</b> 16 A (250V AC)
<b>Usage Category</b>	AC15
<b>Mechanical Life (Min Qty)</b>	50000
<b>Electrical Life (Min Qty)</b>	50000
<b>Operating Frequency (On-Off/Hour)</b>	Mech.900 Elec.900
<b>Insulation Voltage (Ui)</b>	300 V
<b>Impulse Withstand Voltage (Uimp)</b>	2.5 kV
<b>Dielectric Strength (Body-Contact)</b>	2.500V AC
<b>Dielectric Strength (Contact-Contact)</b>	1.500V AC
<b>Isolation Resistance</b>	10 MΩ min. (500V DC)
<b>Operating Temperature</b>	-15 / +80 °C
<b>Pollution Degree</b>	3
<b>Protection Degree</b>	IP65
<b>Contact Material</b>	AgNi
<b>Cable Section</b>	Terminal 6,3*0,8 mm
	1 kA
<b>Specifications</b>	With or w/o illumination options

Black or white body and 4 colour button options

Standards / Certificates TS EN 61058-1

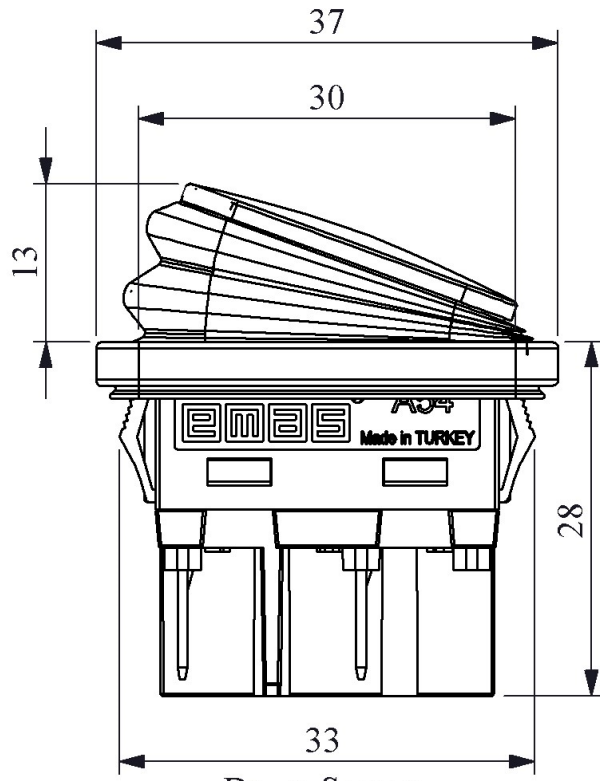



Devre Şeması

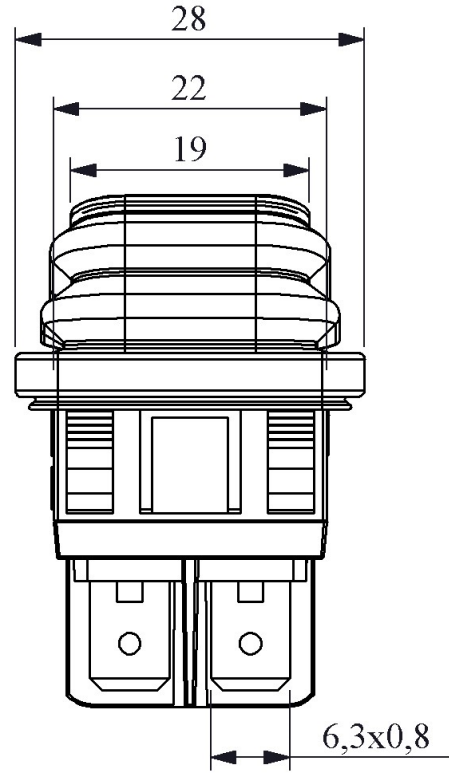
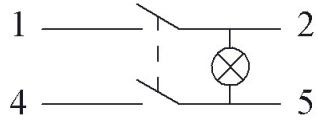

Montaj Ölçüsü 30,2x22,2mm