

**B101DH**

<b>Product</b>		Control Unit
<b>Model</b>		Spring
<b>Type</b>		Flush
<b>Contact</b>		2NO
<b>Color</b>		Black
<b>Dia</b>		22 mm
<b>Current</b>	<b>Ie</b>	4 A (250V AC)
<b>Usage Category</b>		AC 15
<b>Mechanical Life</b>	<b>Min Qty</b>	500000
<b>Electrical Life</b>	<b>Min Qty</b>	100000
<b>Operating Frequency</b>	<b>On-Off/Hour</b>	Mech. 3000 Elec. 1200
<b>Insulation Voltage</b>	<b>Ui</b>	300V
<b>Impulse Withstand Voltage</b>	<b>Uimp</b>	2.5 kV
<b>Dielectric Strength (Body-Contact)</b>		2.500V AC
<b>Dielectric Strength (Contact-Contact)</b>		1.500V AC
<b>Isolation Resistance</b>		10 MΩ min. (500V DC)
<b>Operating Temperature</b>		-15 / + 80 °C
<b>Pollution Degree</b>		3
<b>Protection Degree</b>		IP50
<b>Contact Material</b>		AgNi
<b>Cable Section</b>		1.5-2.5 mm <sup>2</sup>
<b>Screw Torque</b>		1,5 Nm
<b>Short Circuit Breaking Capacity</b>	<b>Ics</b>	1 kA
<b>Production Time</b>		31.12.1899 00:00:00
<b>Serial</b>		B Series Plastic
<b>Specifications</b>		Non-flammable V0 PA6.6 contact blocks
		Various illumination contact blocks availability
		Variety of products for all areas of application

Standards / Certificates IEC 60947-5-1 TS EN 60947-5-1 UL 508 VDE 0660

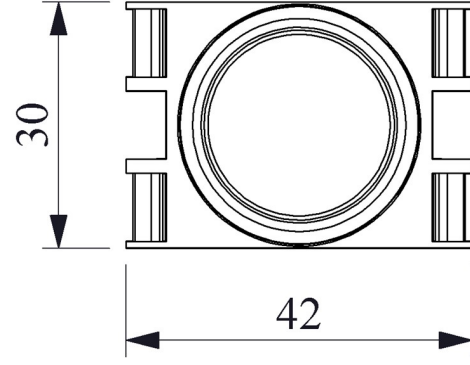

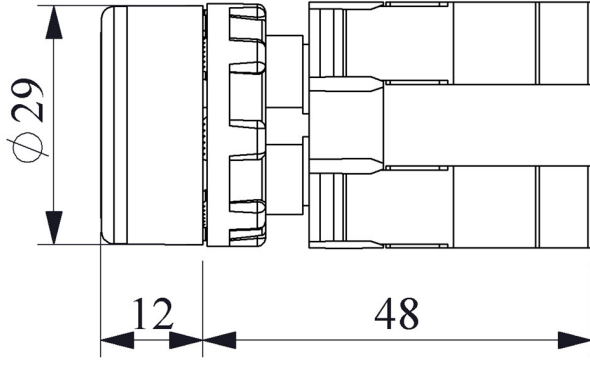

Devre Şeması

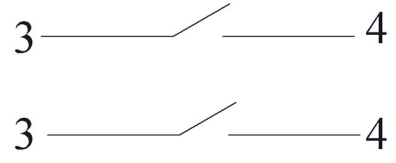

Montaj Ölçüsü  $\text{Ø}22.4 \pm 0.2 \text{ mm}$