

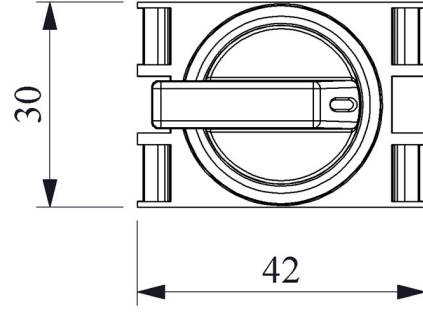

B101S30

Product		Control Unit
Model		Selector
Type		Stay Put
Label/Position		(II-0-I) 60°
Contact		2NO
Dia		22 mm
Current	Ie	4 A (250V AC)
Usage Category		AC 15
Mechanical Life	Min Qty	500000
Electrical Life	Min Qty	100000
Operating Frequency	On-Off/Hour	Mech. 3000 Elec. 1200
Insulation Voltage	Ui	300V
Impulse Withstand Voltage	Uimp	2.5 kV
Dielectric Strength (Body-Contact)		2.500V AC
Dielectric Strength (Contact-Contact)		1.500V AC
Isolation Resistance		10 MΩ min. (500V DC)
Operating Temperature		-15 / + 80 °C
Pollution Degree		3
Protection Degree		IP50
Contact Material		AgNi
Cable Section		1.5-2.5 mm ²
Screw Torque		1,5 Nm
Short Circuit Breaking Capacity	Ics	1 kA
Production Time		31.12.1899 00:00:00
Serial		B Series Plastic
Specifications		Non-flammable V0 PA6.6 contact blocks
		Various illumination contact blocks availability
		Variety of products for all areas of application

Standards / Certificates IEC 60947-5-1 TS EN 60947-5-1 UL 508 VDE 0660

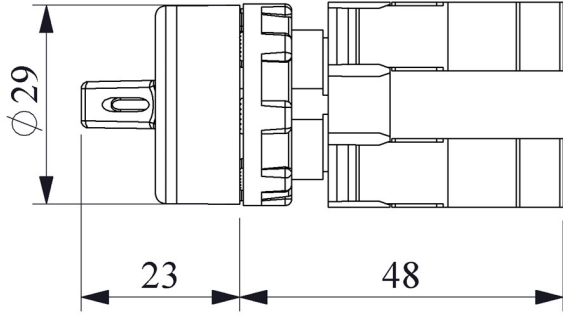



Montaj Ölçüsü $\phi 22.4 \pm 0.2$ mm

Devre Şeması

Pozisyon

