

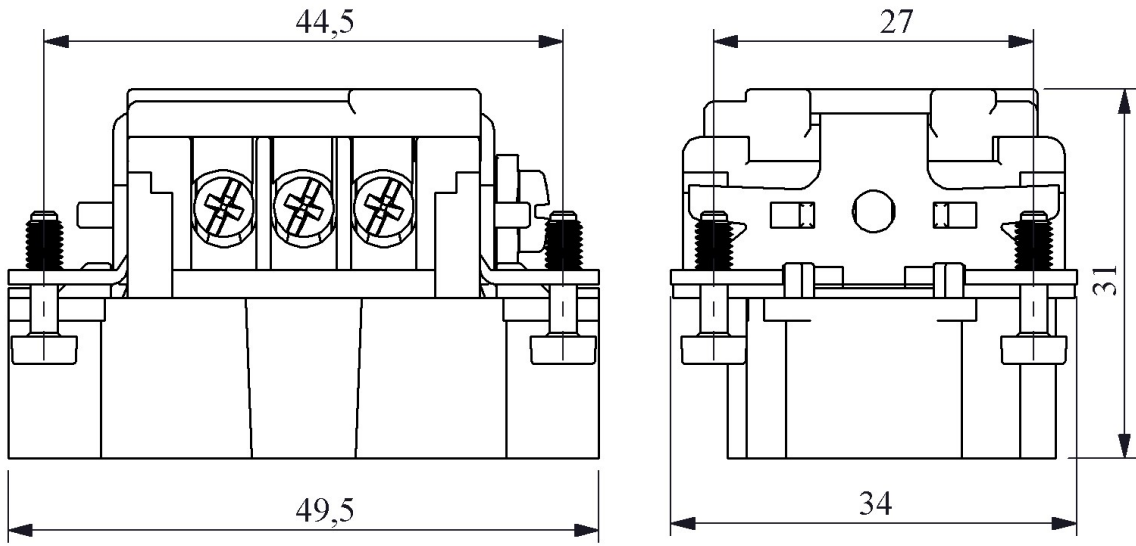

EB006CF00

Print		1-6
Operating Current		16A
Product		Multipole
Type		Insert Plug
Contact		6 Poles
Usage Category		AC15
Mechanical Life	Min Qty	≥ 500
Electrical Life	Min Qty	≥ 100
Operating Frequency	On-Off/Hour	Mech.240 Elec.120
Insulation Voltage	Ui	690V
Impulse Withstand Voltage	Uimp	6 kV
Dielectric Strength (Body-Contact)		1890V AC
Dielectric Strength (Contact-Contact)		3000V AC
Isolation Resistance		10 MΩ Min. (500 V DC)
Operating Temperature		-40 / +125 °C
Pollution Degree		2
Production Time		31.12.1899 00:00:00
Serial		EB Series
Specifications	Wide product variety	
	IP65 in closed position	
	Universal inserts	
	Easy cabling	
	Different locking types	
Powdercoated metal housing		

Standards / Certificates TS EN 61984

Kontak Sayısı: 6P+E