



L3K13SOP103

Product		Limit Switch
Contact		1NO+1NC
Actuator		Spring Lever
Actuator Dia		7 mm
Current	I_e	3 A (240V AC)
Usage Category		AC15
Mechanical Life	Min Qty	10000000
Electrical Life	Min Qty	1000000
Operating Frequency	On-Off/Hour	Mech. 3000 Elec. 1800
Insulation Voltage	U_i	300 V
Impulse Withstand Voltage	U_{imp}	2.5 kV
Dielectric Strength (Body-Contact)		1.890V AC
Dielectric Strength (Contact-Contact)		1.890V AC
Isolation Resistance		10 MΩ (500 V DC)
Operating Temperature		-25 / + 80 °C
Pollution Degree		3
Protection Degree		IP65
Contact Material		AgNi
Cable Section		1-2.5 mm ²
Screw Torque		1.5Nm
Short Circuit Breaking Capacity	I_{cs}	1 kA
Production Time		31.12.1899 00:00:00
Serial		L3 Plastic Body
Contact Action		Snap Action
Actuator Material		Plastic Blunt
Specifications		Plastic Body and Plastic Cover
		One side PG13,5 hole

Various actuator options with wide sensitive contact block alternatives for all kind of applications

Standards / Certificates TS EN 60947-5-1 UL 508 VDE 0660



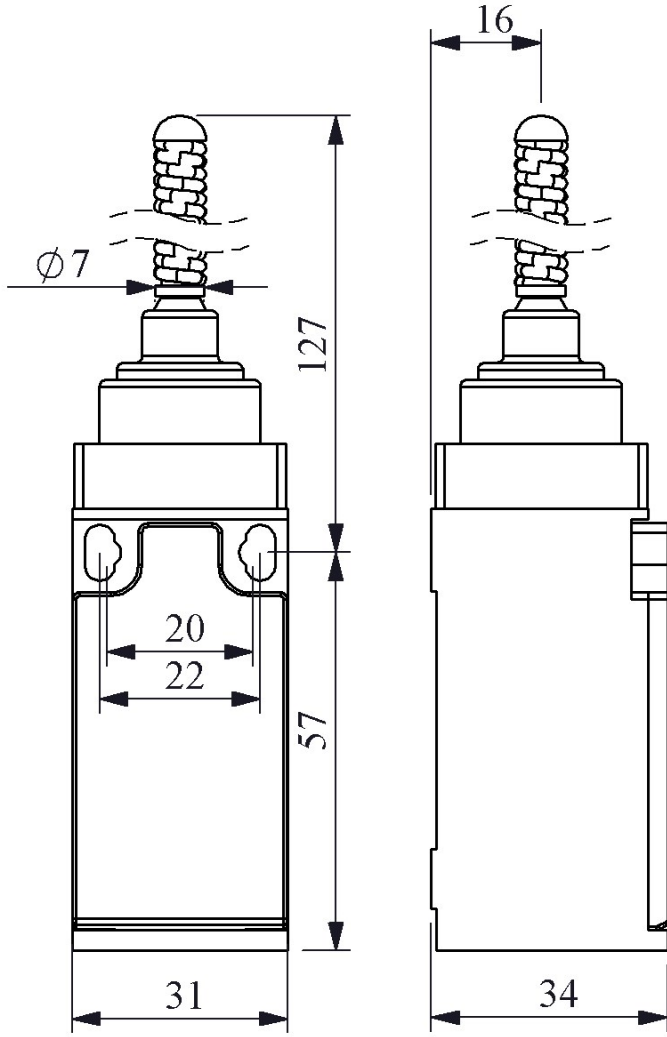

Devre Şeması

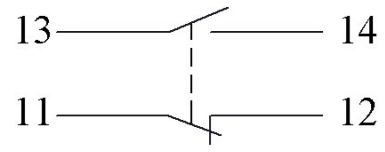

Ani Hareketli



Akış Diyagramı