



L53K13LEM511

Product	Limit Switch	
Contact	1NO+1NC	
Actuator	Safety Door Hinge Switch	
Current	I_e	3 A (240V AC)
Usage Category	AC15	
Mechanical Life	Min Qty	10000000
Electrical Life	Min Qty	1000000
Operating Frequency	On-Off/Hour	Mech. 3000 Elec. 1800
Insulation Voltage	U_i	300 V
Impulse Withstand Voltage	U_{imp}	2.5 kV
Dielectric Strength (Body-Contact)	1.890V AC	
Dielectric Strength (Contact-Contact)	1.890V AC	
Isolation Resistance	10 MΩ (500 V DC)	
Operating Temperature	-25 / + 80 °C	
Pollution Degree	3	
Protection Degree	IP65	
Contact Material	AgNi	
Cable Section	1-2.5 mm ²	
Screw Torque	1.5Nm	
Short Circuit Breaking Capacity	I_{cs}	1 kA
Production Time	31.12.1899 00:00:00	
Serial	L53 Metal Body	
Contact Action	Snap Action	
Actuator Material	Metal	
Specifications	Metal Body and Cover	
	3 side PG13,5 holes	
	Various actuator options with wide sensitive contact block alternatives for all kind of applications	

Standards / Certificates TS EN 60947-5-1 UL 508 VDE 0660



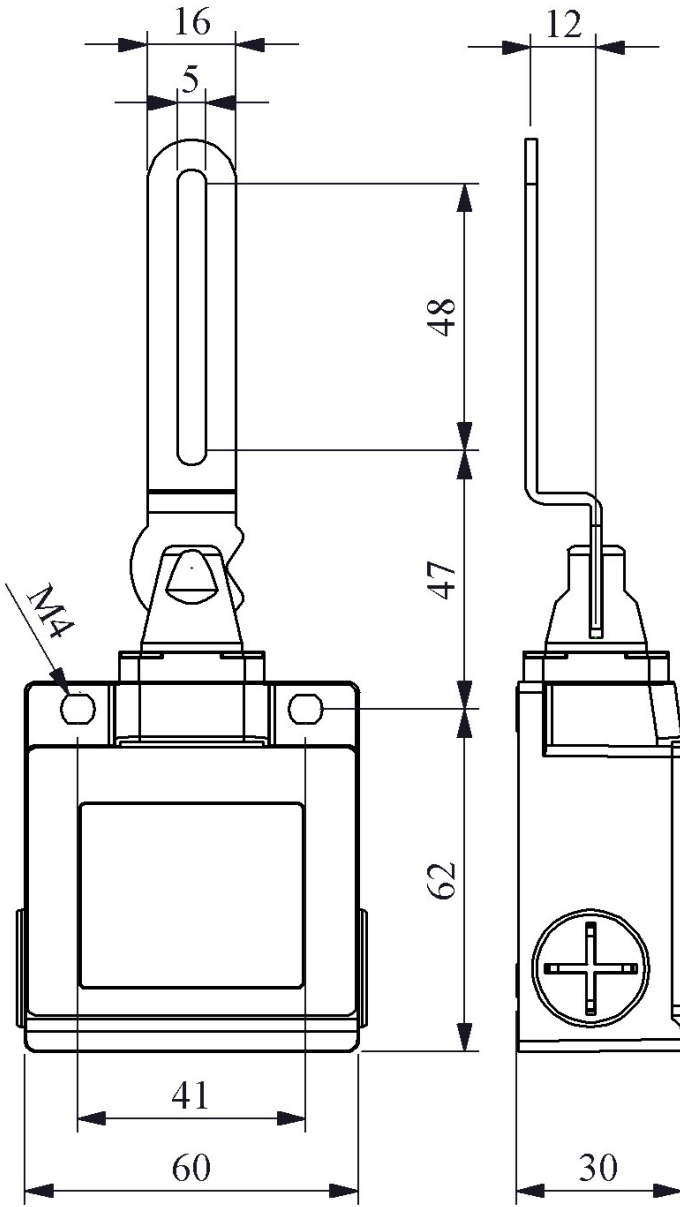

Devre Şeması

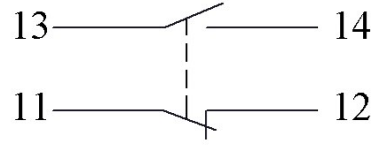

Ani Hareketli

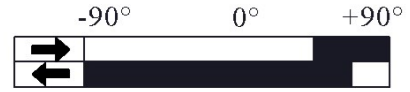

Akış Diyagramı