



### L53K13LEM622

Product		Limit Switch
Contact		1NO+1NC
Actuator		Safety Door Hinge Switch
Current	<b>I<sub>e</sub></b>	3 A (240V AC)
Usage Category		AC15
Mechanical Life	<b>Min Qty</b>	10000000
Electrical Life	<b>Min Qty</b>	1000000
Operating Frequency	<b>On-Off/Hour</b>	Mech. 3000 Elec. 1800
Insulation Voltage	<b>U<sub>i</sub></b>	300 V
Impulse Withstand Voltage	<b>U<sub>imp</sub></b>	2.5 kV
Dielectric Strength (Body-Contact)		1.890V AC
Dielectric Strength (Contact-Contact)		1.890V AC
Isolation Resistance		10 MΩ (500 V DC)
Operating Temperature		-25 / + 80 °C
Pollution Degree		3
Protection Degree		IP65
Contact Material		AgNi
Cable Section		1-2.5 mm <sup>2</sup>
Screw Torque		1.5Nm
Short Circuit Breaking Capacity	<b>I<sub>cs</sub></b>	1 kA
Production Time		31.12.1899 00:00:00
Serial		L53 Metal Body
Contact Action		Snap Action
Actuator Material		Metal
Specifications		Metal Body and Cover
		3 side PG13,5 holes
		Various actuator options with wide sensitive contact block alternatives for all kind of applications

Standards / Certificates TS EN 60947-5-1 UL 508 VDE 0660



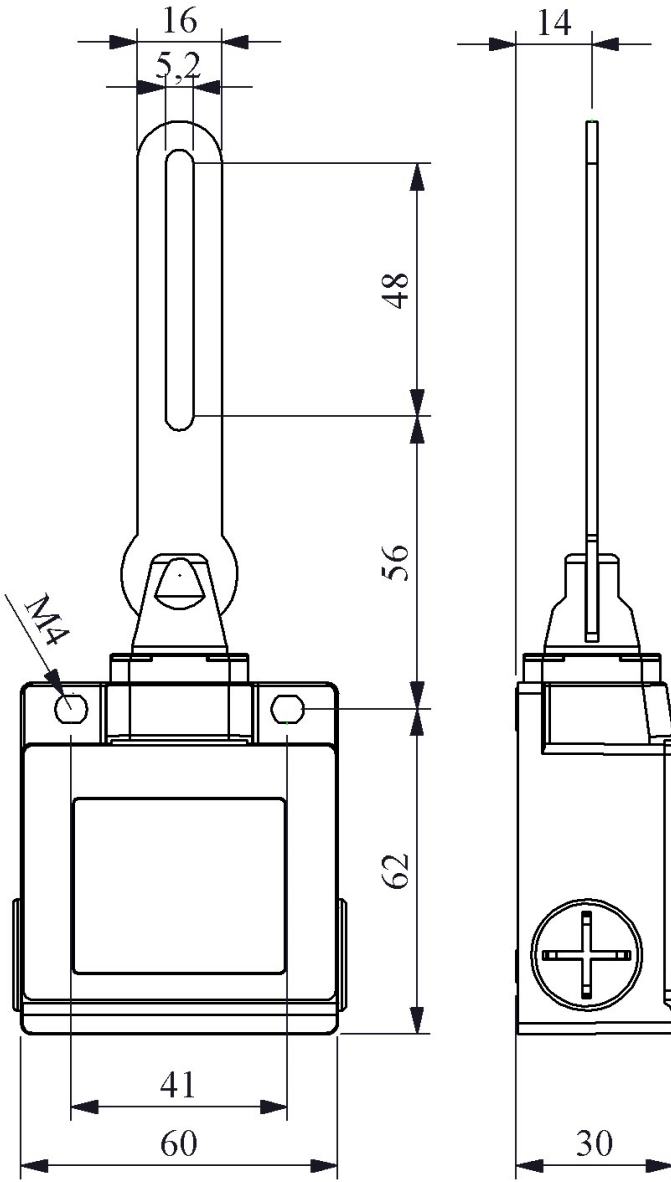

Devre Şeması

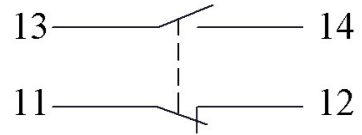

Ani Hareketli



Akış Diyagramı