



L53K13MEP123

Product		Limit Switch
Contact		1NO+1NC
Actuator		Adjustable Roller Arm
Actuator Dia		18 mm
Current	I_e	3 A (240V AC)
Usage Category		AC15
Mechanical Life	Min Qty	10000000
Electrical Life	Min Qty	1000000
Operating Frequency	On-Off/Hour	Mech. 3000 Elec. 1800
Insulation Voltage	U_i	300 V
Impulse Withstand Voltage	U_{imp}	2.5 kV
Dielectric Strength (Body-Contact)		1.890V AC
Dielectric Strength (Contact-Contact)		1.890V AC
Isolation Resistance		10 MΩ (500 V DC)
Operating Temperature		-25 / + 80 °C
Pollution Degree		3
Protection Degree		IP65
Contact Material		AgNi
Cable Section		1-2.5 mm ²
Screw Torque		1.5Nm
Short Circuit Breaking Capacity	I_{cs}	1 kA
Production Time		31.12.1899 00:00:00
Serial		L53 Metal Body
Contact Action		Snap Action
Actuator Material		Plastic
Specifications		Metal Body and Cover 3 side PG13,5 holes

Various actuator options with wide sensitive contact block alternatives for all kind of applications

Standards / Certificates TS EN 60947-5-1 UL 508 VDE 0660



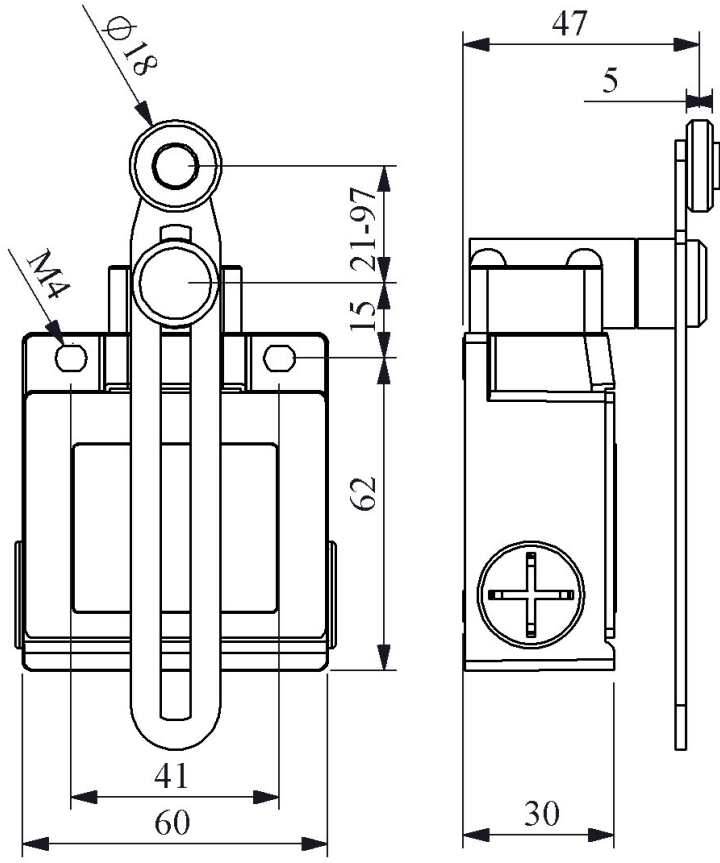

Devre Şeması

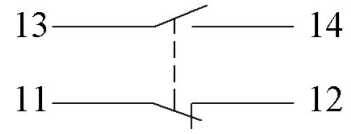

Ani Hareketli



Akış Diyagramı