

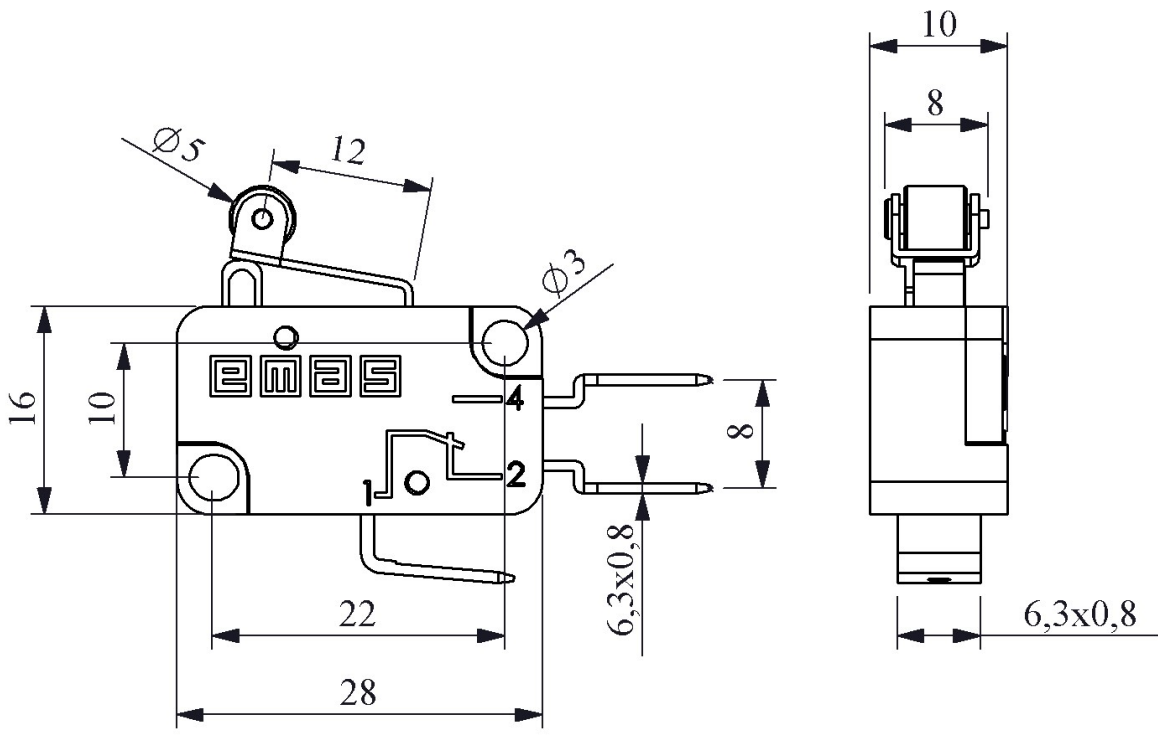

MK1MIM1

Product		Micro Switch
Contact		1CO
Actuator		Short Lever Roller
Current	I_e	6 A (250V AC)
Usage Category		AC15
Mechanical Life	Min Qty	10000000
Electrical Life	Min Qty	100000
Operating Frequency	On-Off/Hour	Mech. 3000 Elec. 1200
Insulation Voltage	U_i	660V
Impulse Withstand Voltage	U_{imp}	2.5 kV
Dielectric Strength (Body-Contact)		1.890V AC
Dielectric Strength (Contact-Contact)		1.890V AC
Isolation Resistance		10 MΩ min. (500V DC)
Operating Temperature		-25 / +80 °C
Pollution Degree		3
Protection Degree		IP20
Contact Material		AgNi
Cable Section		Terminal 6,3*0,8 mm
Short Circuit Breaking Capacity	I_{cs}	1 kA
Serial		MK1 Series
Actuator Material		Metal
Specifications		Maximum product reliability with V0 material
		Different actuator options
Standards / Certificates		TS EN 60947-5-1





Devre Şeması

