

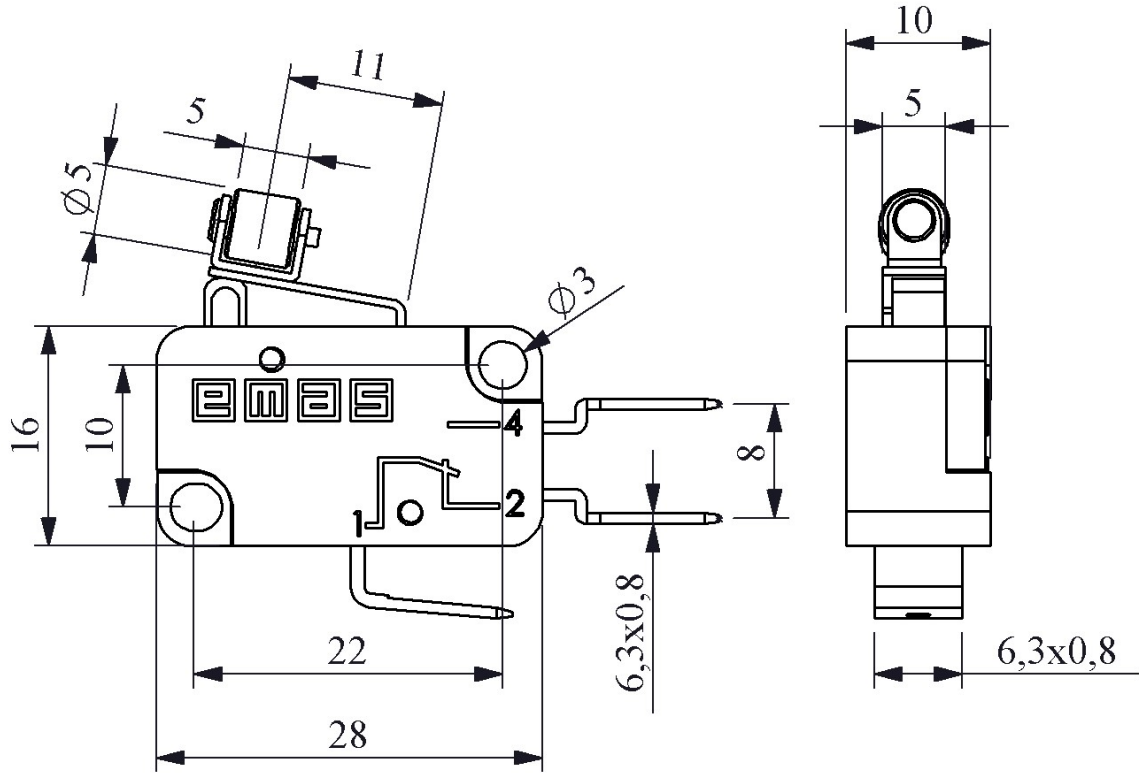

MK1MIM4

Product	Micro Switch
Serial	MK1 Series
Actuator Material	Metal
Actuator	Short Lever Roller
Contact	1CO
Current	Ie 6 A (250V AC)
Usage Category	AC15
Mechanical Life (Min Qty)	10000000
Electrical Life (Min Qty)	100000
Operating Frequency (On-Off/Hour)	Mech. 3000 Elec. 1200
Insulation Voltage (Ui)	660V
Impulse Withstand Voltage (Uimp)	2.5 kV
Dielectric Strength (Body-Contact)	1.890V AC
Dielectric Strength (Contact-Contact)	1.890V AC
Isolation Resistance	10 MΩ min. (500V DC)
Operating Temperature	-25 / +80 °C
Pollution Degree	3
Protection Degree	IP20
Contact Material	AgNi
Cable Section	Terminal 6,3*0,8 mm 1 kA
Specifications	V0 material Different actuator options
Standards / Certificates	TS EN 60947-5-1



Devre Şeması

