

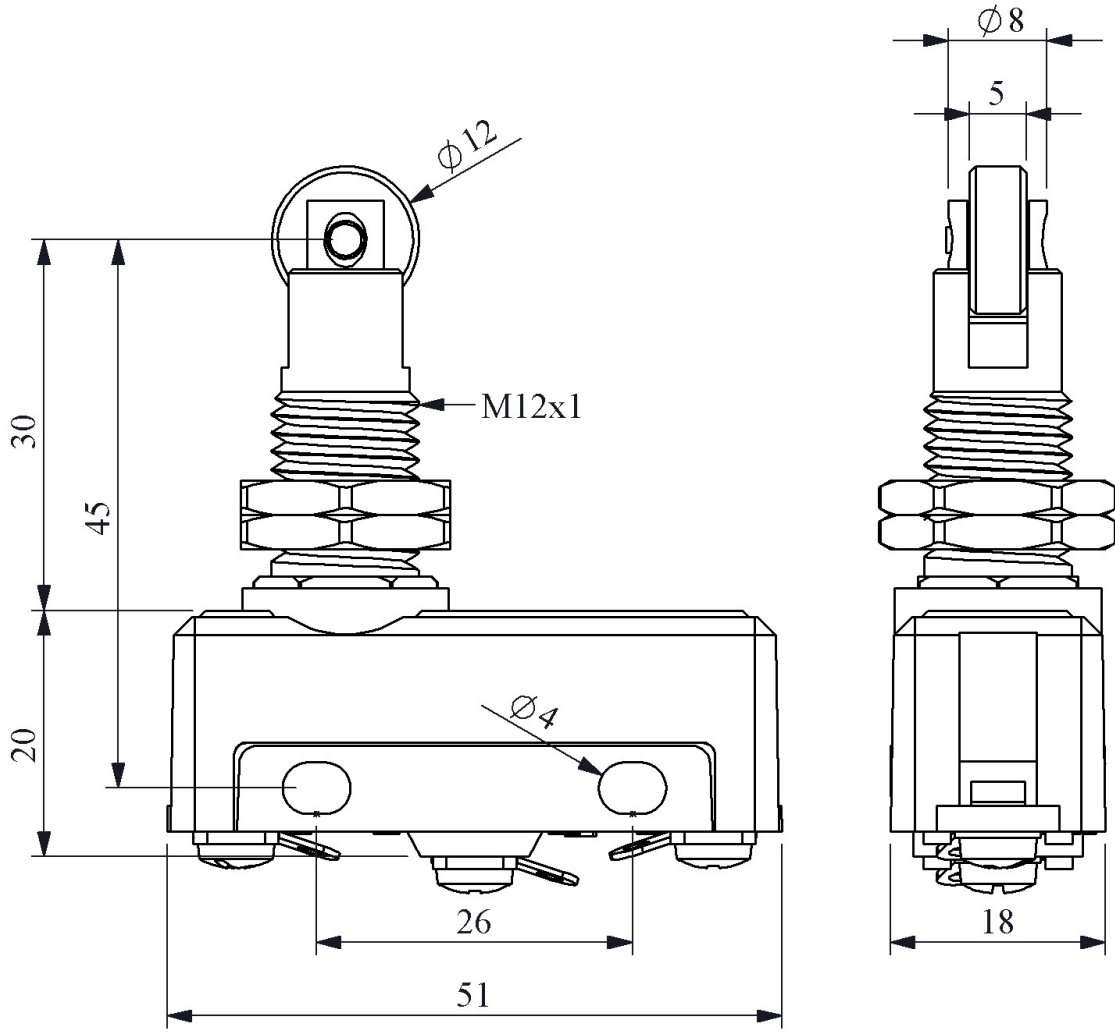

### MN2MUM3

Product	Plastic Mini Switch	
Contact	1CO	
Actuator	Roller Plunger	
Current	<b>I<sub>e</sub></b>	6 A (250V AC)
Usage Category	AC15	
Mechanical Life	<b>Min Qty</b>	500000
Electrical Life	<b>Min Qty</b>	100000
Operating Frequency	<b>On-Off/Hour</b>	Mech. 3000 Elec. 1200
Insulation Voltage	<b>U<sub>i</sub></b>	660V
Impulse Withstand Voltage	<b>U<sub>imp</sub></b>	2.5 kV
Dielectric Strength (Body-Contact)	1.890V AC	
Dielectric Strength (Contact-Contact)	1.890V AC	
Isolation Resistance	10 MΩ min. (500V DC)	
Operating Temperature	-25 / +80 °C	
Pollution Degree	3	
Protection Degree	IP20 (IP40 Koruma Kapaklı)	
Contact Material	AgNi	
Cable Section	1-2.5 mm <sup>2</sup>	
Screw Torque	1,5 Nm	
Short Circuit Breaking Capacity	<b>I<sub>cs</sub></b>	1 kA
Serial	MN2 Series	
Actuator Material	Metal	
Specifications	Maximum product reliability with V0 material	
	Different actuator options	
	Standard mounting holes	
Standards / Certificates	TS EN 60947-5-1	





Devre Şeması

