



### P1C304M72

<b>Product</b>	Control Box	
<b>Color</b>	Grey-Black	
<b>Current</b>	<b>Ie</b>	4A (250V AC)
<b>Usage Category</b>	AC15	
<b>Mechanical Life</b>	<b>Min Qty</b>	1000000
<b>Electrical Life</b>	<b>Min Qty</b>	100000
<b>Operating Frequency</b>	<b>On-Off/Hour</b>	Mech. 3000 Elec. 1200
<b>Insulation Voltage</b>	<b>Ui</b>	300 V
<b>Impulse Withstand Voltage</b>	<b>Uimp</b>	2.5 kV
<b>Dielectric Strength (Body-Contact)</b>	2.500V AC	
<b>Dielectric Strength (Contact-Contact)</b>	1.500V AC	
<b>Isolation Resistance</b>	10 MΩ (500 V DC)	
<b>Operating Temperature</b>	-15 / + 80 °C	
<b>Pollution Degree</b>	3	
<b>Protection Degree</b>	IP65	
<b>Contact Material</b>	AgNi	
<b>Cable Section</b>	1.5-2.5 mm <sup>2</sup>	
<b>Screw Torque</b>	1.5Nm	
<b>Short Circuit Breaking Capacity</b>	<b>Ics</b>	1kA
<b>Serial</b>	P Series Plastic	
<b>Hole Qty</b>	1 Hole	
<b>Ingredients</b>	CPDM72K + C3CK (NO) + C4CK (NC)	
<b>Specifications</b>	Suitable for Ø22 mm buttons	
	Strong resistance against mechanical strokes	
	IP65 with suitable buttons	
	Body types in different dimensions	
<b>Standards / Certificates</b>	TS EN 60947-5-1 UL 508 VDE 0660	

CE

ERT



PIC304M72

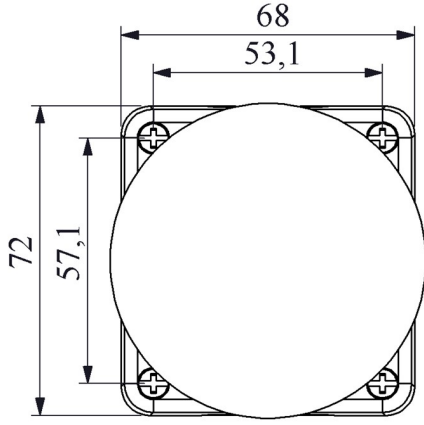

Devre Şeması

