

**PSA016AK331B**

Product		Cam Switch
Label/Position		(0-1)
Switch Type		On-Off
Pole / Phase		3 Phase
Frame Size		64*64
Current	Ie	16A
Usage Category		AC21A
Mechanical Life	Min Qty	100000
Electrical Life	Min Qty	50000
Operating Frequency	On-Off/Hour	Mech.120 Elec.120
Insulation Voltage	Ui	690V
Impulse Withstand Voltage	Uimp	4 kV
Dielectric Strength (Body-Contact)		1.890V AC
Dielectric Strength (Contact-Contact)		1.890V AC
Isolation Resistance		10 MΩ MIN. (500 V DC)
Operating Temperature		-25 / +80 °C
Pollution Degree		3
Protection Degree		IP54
Contact Material		AgNi
Cable Section		1-2,5 mm ²
Spin Angle		60°
Short Circuit Breaking Capacity	Ics	6 kA
Serial		PSA Series
Specifications		High precision
		Variety of products for wide application fields
		Long life time
		Compact design
Standards / Certificates		TS EN 60947-3

CE

ERT



TSE

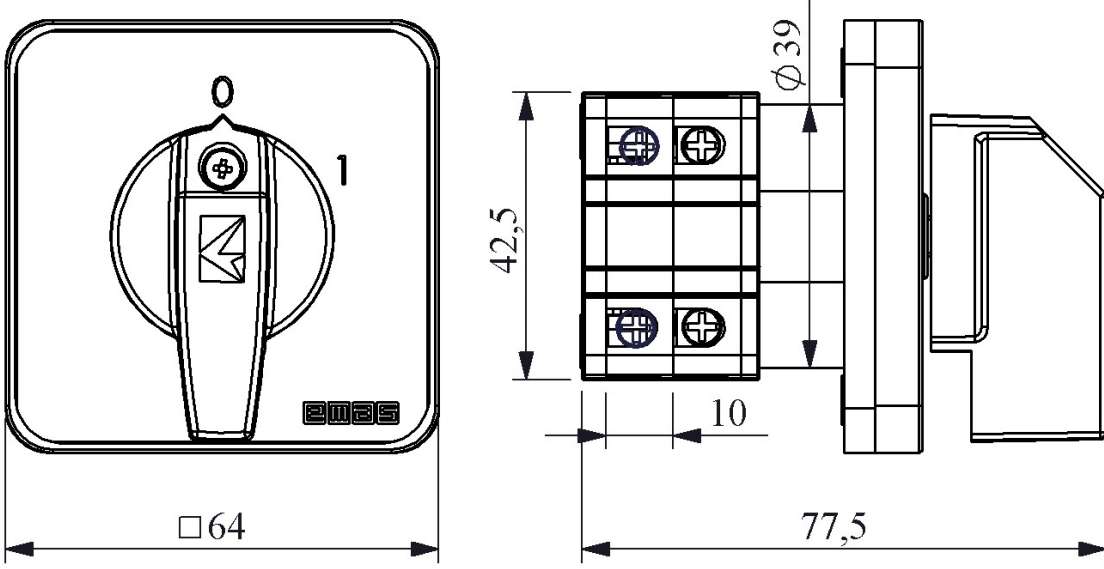

Devre Şeması

	1	3	5
	2	4	6
0			
1	X	X	X

