



PSA025KD134S

Product	Cam Switch	
Label/Position	(1-0-2)	
Switch Type	Changeover	
Pole / Phase	1 Poles	
Frame Size	48*48	
Current	Ie	25A
Usage Category	AC21A	
Mechanical Life	Min Qty	100000
Electrical Life	Min Qty	50000
Operating Frequency	On-Off/Hour	Mech.120 Elec.120
Insulation Voltage	Ui	690V
Impulse Withstand Voltage	Uimp	4 kV
Dielectric Strength (Body-Contact)	1.890V AC	
Dielectric Strength (Contact-Contact)	1.890V AC	
Isolation Resistance	10 MΩ MIN. (500 V DC)	
Operating Temperature	-25 / +80 °C	
Pollution Degree	3	
Protection Degree	IP54	
Contact Material	AgNi	
Cable Section	1-2,5 mm ²	
Spin Angle	60°	
Short Circuit Breaking Capacity	Ics	6 kA
Serial	PSA Series	
Specifications	High precision	
	Variety of products for wide application fields	
	Long life time	
	Compact design	
Standards / Certificates	TS EN 60947-3	

CE

ERT



TSE

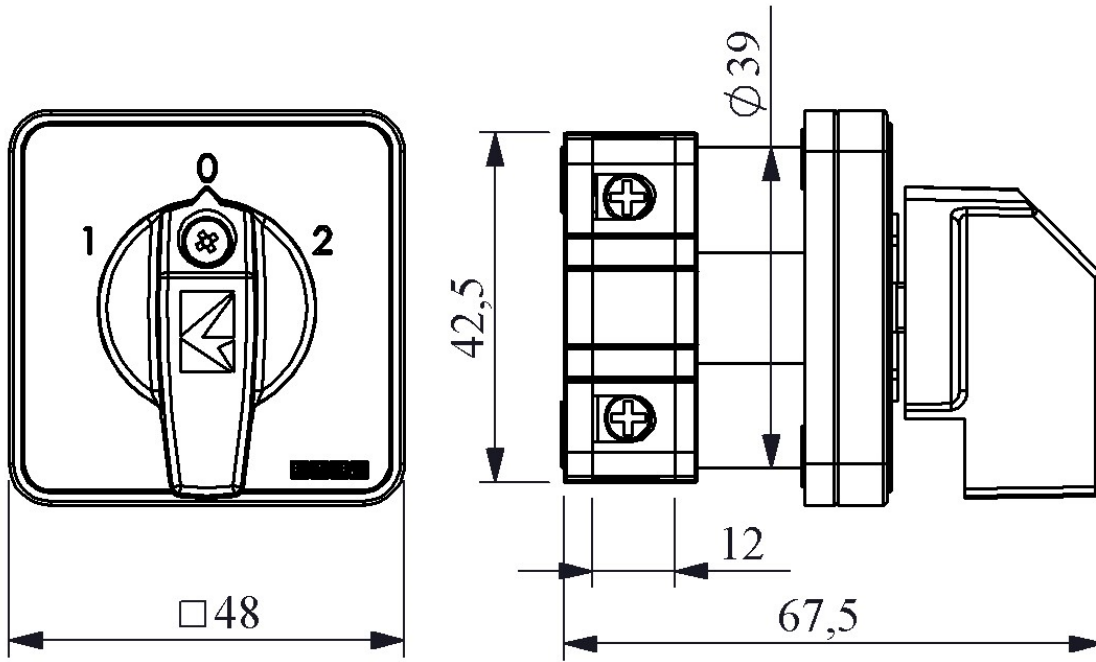

Devre Şeması

	1	3
	2	4
1	X	
0		
2		X

