



### PSA025KD234S

Product	Cam Switch	
Label/Position	(1-0-2)	
Switch Type	Changeover	
Pole / Phase	2 Poles	
Frame Size	48*48	
Current	<b>Ie</b>	25A
Usage Category	AC21A	
Mechanical Life	<b>Min Qty</b>	100000
Electrical Life	<b>Min Qty</b>	50000
Operating Frequency	<b>On-Off/Hour</b>	Mech.120 Elec.120
Insulation Voltage	<b>Ui</b>	690V
Impulse Withstand Voltage	<b>Uimp</b>	4 kV
Dielectric Strength (Body-Contact)	1.890V AC	
Dielectric Strength (Contact-Contact)	1.890V AC	
Isolation Resistance	10 MΩ MIN. (500 V DC)	
Operating Temperature	-25 / +80 °C	
Pollution Degree	3	
Protection Degree	IP54	
Contact Material	AgNi	
Cable Section	1-2,5 mm <sup>2</sup>	
Spin Angle	60°	
Short Circuit Breaking Capacity	<b>Ics</b>	6 kA
Serial	PSA Series	
Specifications	High precision	
	Variety of products for wide application fields	
	Long life time	
	Compact design	
Standards / Certificates	TS EN 60947-3	

CE

ERT



TSE

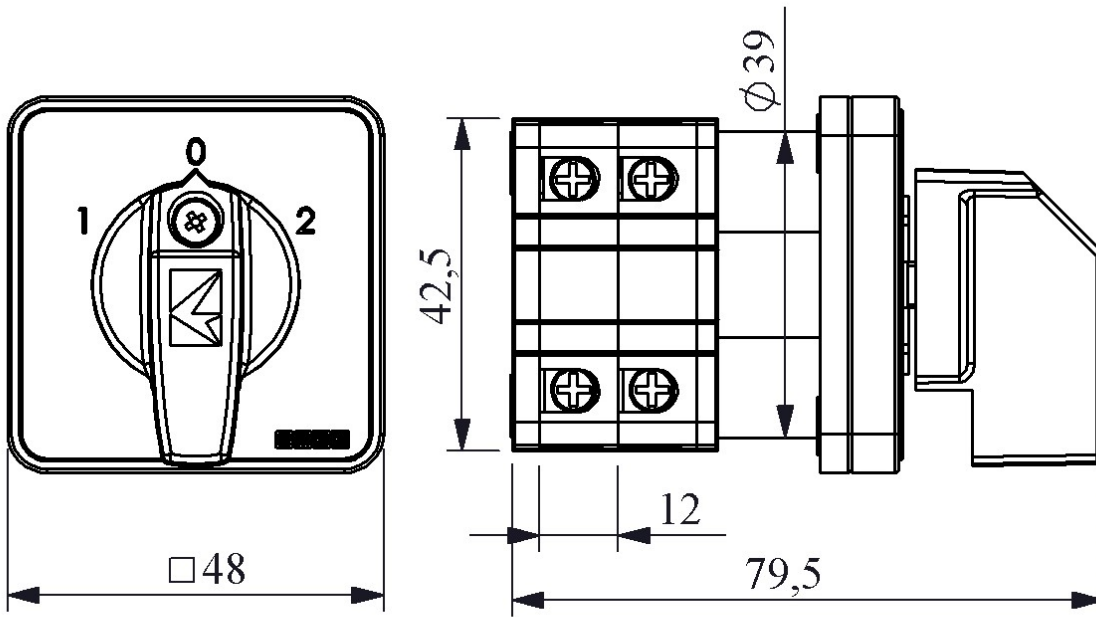

### Devre Şeması

	1	3	5	7
	2	4	6	8
1	X		X	
0				
2		X		X

