

**PSA025KT332S**

<b>Product</b>		Cam Switch
<b>Label/Position</b>		(0-1-2)
<b>Switch Type</b>		Step
<b>Pole / Phase</b>		3 Poles
<b>Frame Size</b>		48*48
<b>Current</b>	<b>Ie</b>	25A
<b>Usage Category</b>		AC21A
<b>Mechanical Life</b>	<b>Min Qty</b>	100000
<b>Electrical Life</b>	<b>Min Qty</b>	50000
<b>Operating Frequency</b>	<b>On-Off/Hour</b>	Mech.120 Elec.120
<b>Insulation Voltage</b>	<b>Ui</b>	690V
<b>Impulse Withstand Voltage</b>	<b>Uimp</b>	4 kV
<b>Dielectric Strength (Body-Contact)</b>		1.890V AC
<b>Dielectric Strength (Contact-Contact)</b>		1.890V AC
<b>Isolation Resistance</b>		10 MΩ MIN. (500 V DC)
<b>Operating Temperature</b>		-25 / +80 °C
<b>Pollution Degree</b>		3
<b>Protection Degree</b>		IP54
<b>Contact Material</b>		AgNi
<b>Cable Section</b>		1-2,5 mm <sup>2</sup>
<b>Spin Angle</b>		60°
<b>Short Circuit Breaking Capacity</b>	<b>Ics</b>	6 kA
<b>Serial</b>		PSA Series
<b>Specifications</b>		High precision
		Variety of products for wide application fields
		Long life time
		Compact design
<b>Standards / Certificates</b>		TS EN 60947-3

CE

ERT



TSE

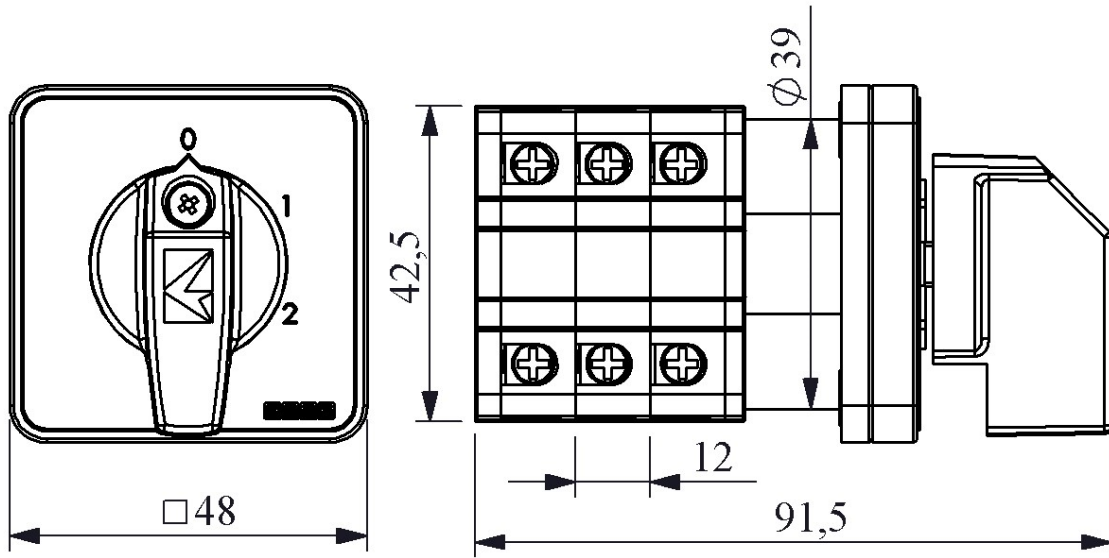

### Devre Şeması

	1	3	5	7	9	11
	2	4	6	8	10	12
0						
1	X		X		X	
2	X	X	X	X	X	X

