



### PSA050KS135S

|  |                    |   |
|--|--------------------|---|
| <b>Product</b>                               |                    | Cam Switch                                      |
| <b>Label/Position</b>                        |                    | (0-5)   |
| <b>Switch Type</b>                           |                    | 5 Steps   |
| <b>Pole / Phase</b>                          |                    | 1 Poles   |
| <b>Frame Size</b>                            |                    | 64*64   |
| <b>Current</b>                               | <b>Ie</b>          | 50A   |
| <b>Usage Category</b>                        |                    | AC21A   |
| <b>Mechanical Life</b>                       | <b>Min Qty</b>     | 100000  |
| <b>Electrical Life</b>                       | <b>Min Qty</b>     | 50000   |
| <b>Operating Frequency</b>                   | <b>On-Off/Hour</b> | Mech.120 Elec.120                               |
| <b>Insulation Voltage</b>                    | <b>Ui</b>          | 690V  |
| <b>Impulse Withstand Voltage</b>             | <b>Uimp</b>        | 4 kV  |
| <b>Dielectric Strength (Body-Contact)</b>    |                    | 1.890V AC                                       |
| <b>Dielectric Strength (Contact-Contact)</b> |                    | 1.890V AC                                       |
| <b>Isolation Resistance</b>                  |                    | 10 MΩ MIN. (500 V DC)                           |
| <b>Operating Temperature</b>                 |                    | -25 / +80 °C                                    |
| <b>Pollution Degree</b>                      |                    | 3   |
| <b>Protection Degree</b>                     |                    | IP54  |
| <b>Contact Material</b>                      |                    | AgNi  |
| <b>Cable Section</b>                         |                    | 6 mm <sup>2</sup>                               |
| <b>Spin Angle</b>                            |                    | 60°   |
| <b>Short Circuit Breaking Capacity</b>       | <b>Ics</b>         | 6 kA  |
| <b>Serial</b>                                |                    | PSA Series                                      |
| <b>Specifications</b>                        |                    | High precision                                  |
|  |                    | Variety of products for wide application fields |
|  |                    | Long life time                                  |
|  |                    | Compact design                                  |
| <b>Standards / Certificates</b>              |                    | TS EN 60947-3                                   |

CE

ERT



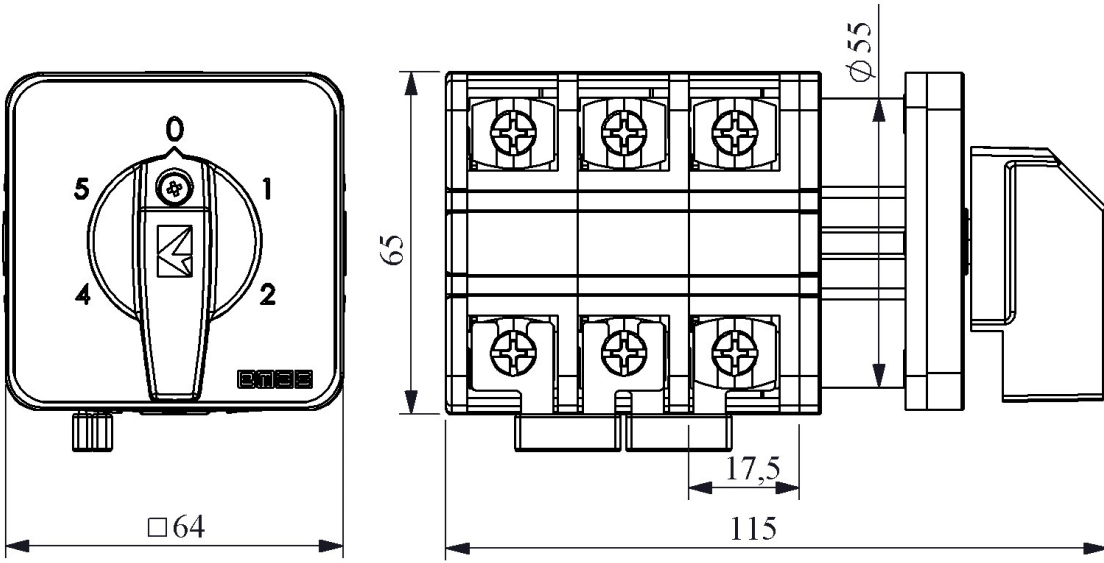

Devre Şeması

