

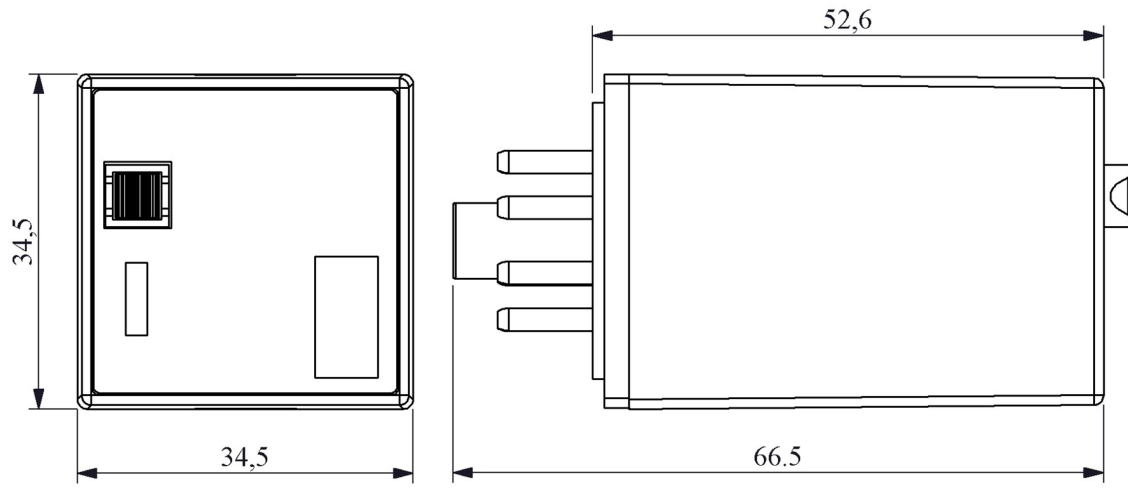

RE1P08DC012

Product	Industrial Relay
Serial	RE1 Series
Operational Voltage	12VDC
Contact	2 Contact
Pin	8 Pin
Current (Ie)	10 A (250V AC)
Usage Category	AC 15
Mechanical Life (Min Qty)	10000000
Electrical Life (Min Qty)	100000
Operating Frequency (On-Off/Hour)	Mech. 18.000 Elec. 600
Insulation Voltage (Ui)	300 V
Impulse Withstand Voltage (Uimp)	1,5kV
Dielectric Strength (Body-Contact)	2.500V AC
Dielectric Strength (Contact-Contact)	1.500V AC
Isolation Resistance	MIN. 10 MΩ (500 V DC)
Operating Temperature	-15 / +80 °C
Pollution Degree	3
Protection Degree	IP40
Contact Material	AgNi
Specifications	V0 PA 6.6 material
	DIN 35mm rail mountable with 8 and 11 pin socket
	Body design and connection ends for quick and error-free assembly
	Test button and indicator
	Large labelling area for code writing
Standards / Certificates	TS EN 61810-1





Devre Şeması

