

RZ1A2C12S-1

Switching Capacity		6000/saat
Connection Type		8 Pins
Operating Current		0.06A
Operational Frequency		50 Hz
Operational Voltage		12VAC/DC
Product		Electronic Relay
Control		Analog
Type		Time
Contact		1CO+1NO
Current	Ie	5A (rezistif)
Power Consumption		0.7W
Mechanical Life	Min Qty	10000000
Electrical Life	Min Qty	100000
Operating Temperature		-5°C...+55°C
Protection Degree		IP30
Contact Material		AgNi
Time Interval		0,1sec-12sec
Maximum Contact Power		150 W, 1,250 VA
Number of Contact		1NO,1 changeover
Repeat Accuracy		±%3
Max. Reset Time		≤100ms
Voltage Interval		(0,85-1.1)*Ue
Indicator		Led
Serial		RZ1 Series
Specifications		Compact design
		Fast and silent switching
		Long life
		Fingerproof design

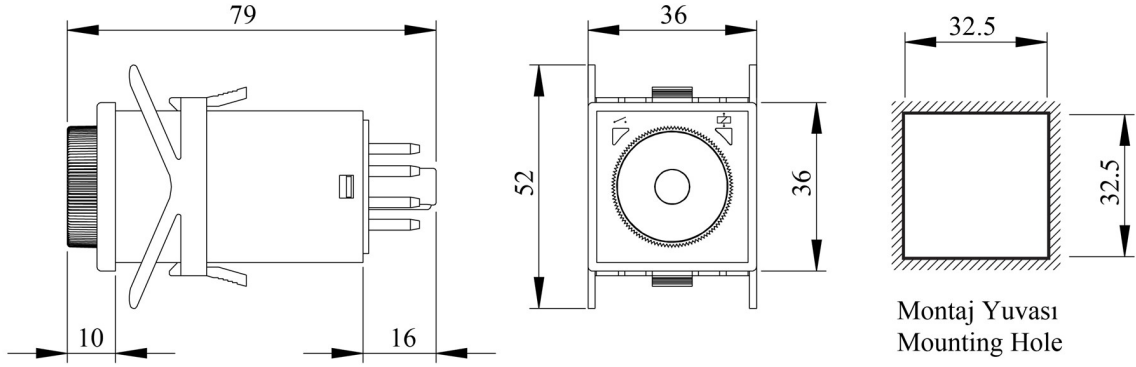

2-7 : Besleme (220 V AC) / Supply (220 V AC)
 Besleme (24 V AC) / Supply (24 V AC)
 Besleme (12V AC) / Supply (12V AC)

1-3 : Ani çıkış kontağı/Instantaneous relay output contact

8-5-6 : Zamana bağlı çıkış kontakları / Timed relay output contacts

