

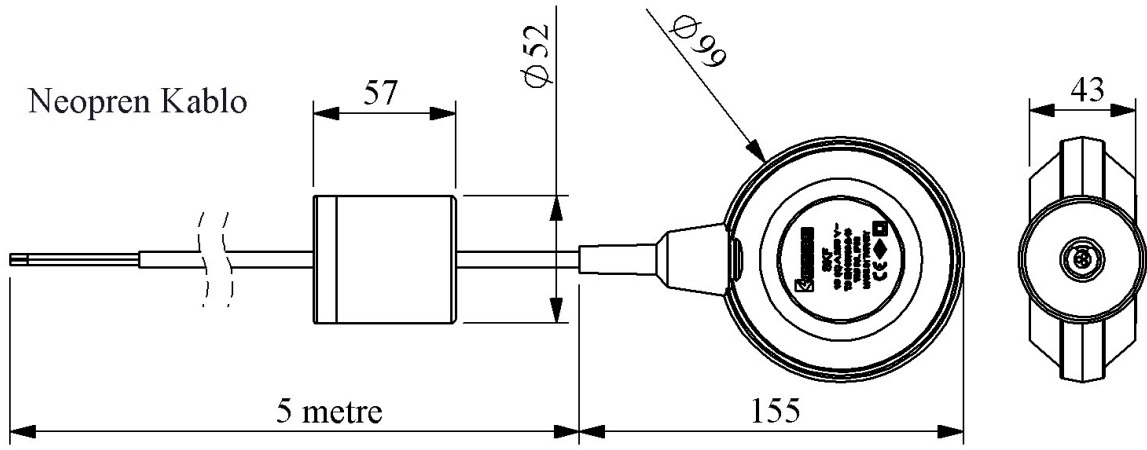

SKF-5N	
Product	Level Control Float Switch
Type	Cobra
Feature	With Standard Weight
Cable	5m
Phase Number	1 Phase
Current	Ie 6 A (250V AC)
Usage Category	AC15
Mechanical Life	Min Qty 30000
Electrical Life	Min Qty 10000
Operating Frequency	On-Off/Hour Mek.120 Elk.120
Insulation Voltage	Ui 660V
Impulse Withstand Voltage	Uimp 2.75 kV
Dielectric Strength (Body-Contact)	2750V AC
Dielectric Strength (Contact-Contact)	1890V AC
Isolation Resistance	10 MΩ Min. (500 V DC)
Operating Temperature	-15 / + 80 °C
Protection Degree	IP68
Contact Material	AgNi
Cable Section	3*1 mm Kablo
Serial	SKF Series
Cable Type	Neoprene
Specifications	Easy assembly
	Feature to adjust the requested operation interval with weight
	Different cable length options
	Waterproof
Standards / Certificates	TS EN 60730-2-15



Devre Şeması

— Mavi

Siyah — Kahverengi