

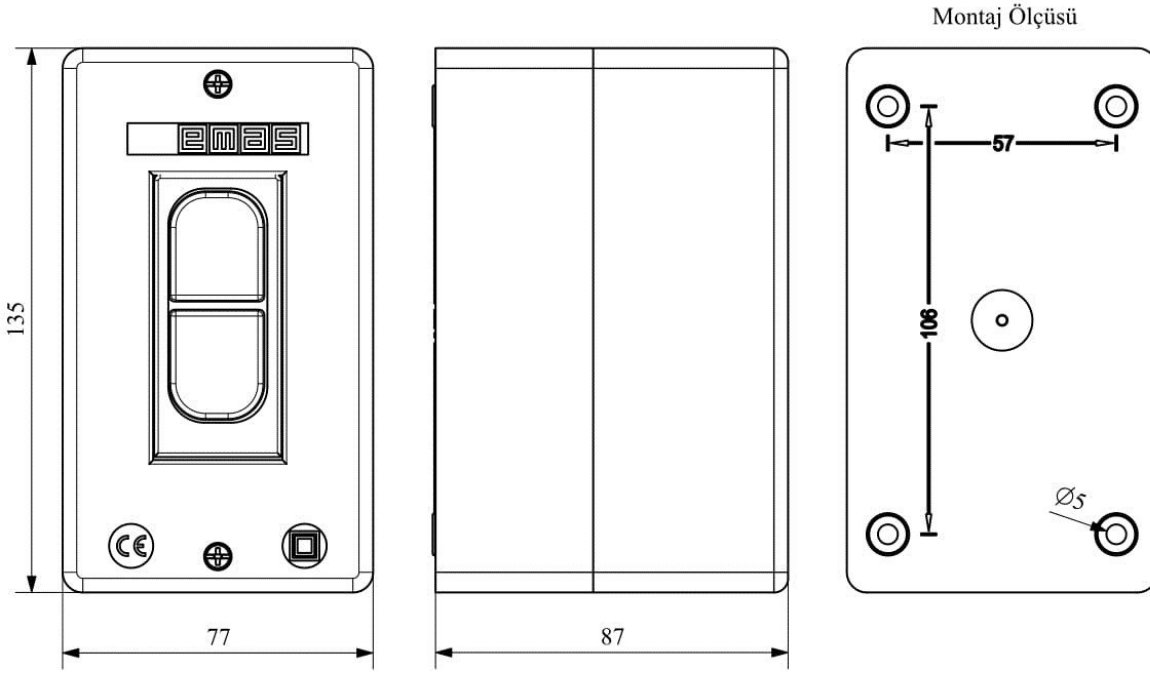

TSP-0,70

Product	Thermic Protection Switch
Serial	TS Series
Thermic Current Calibration Interval	0,40-0,70A
Feature	with Enclosure
Operational Frequency	50-60 Hz
Current (Ie)	16 A
Usage Category	AC 3
Mechanical Life (Min Qty)	10000
Electrical Life (Min Qty)	10000
Operating Frequency (On-Off/Hour)	Mek. 360 Elk. 360
Insulation Voltage (Ui)	690V AC
Impulse Withstand Voltage (Uimp)	6 kV
Dielectric Strength (Contact-Contact)	1890V
Isolation Resistance	10 MΩ Min. (500 V DC)
Operating Temperature	-5 / +40 °C
Pollution Degree	3
Protection Degree	IP55
Cable Section	0,75-4 mm ²
Screw Torque	1,8 Nm
Specifications	11 different product options between 0.32 - 16 A
	Surface mounted and flush mounted
	IP65 Boxed
Standards / Certificates	TS EN 60947-4-1





Elektrik Şeması

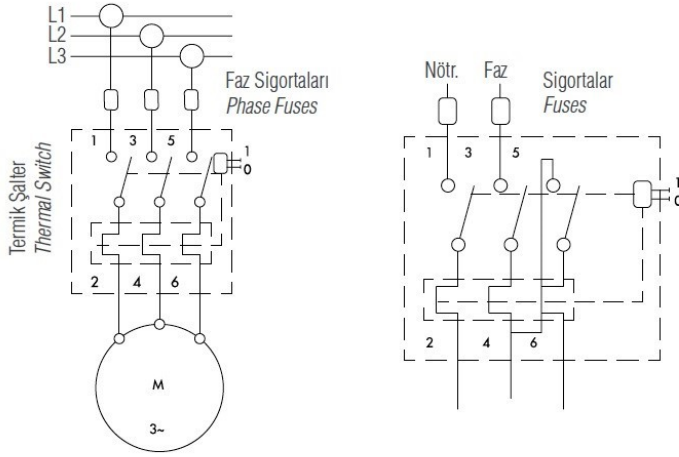

Trifaze Bağlantı

Monofaze Bağlantı