

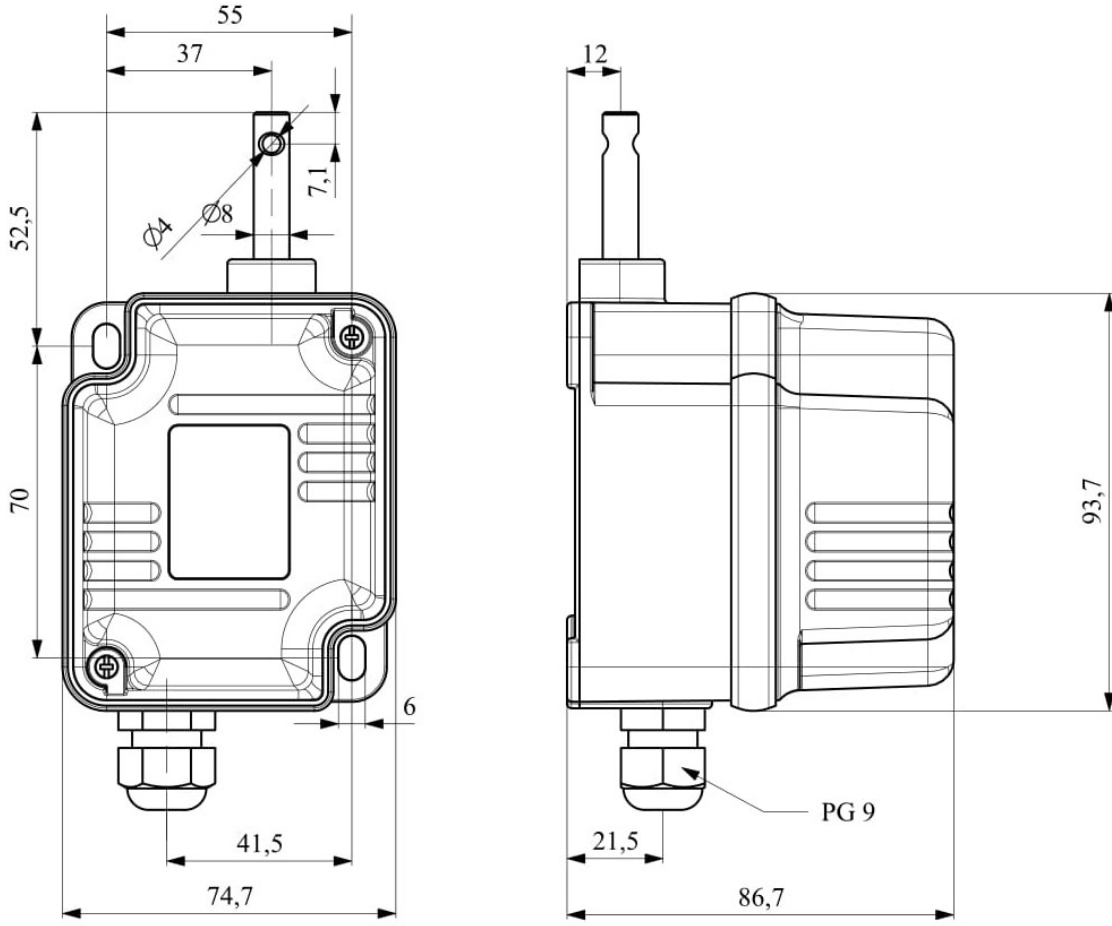

VT3025D

Product	Rotational Limit Switch	
Type	1/25	
Contact	3*CO	
Current	Ie	10 A (250V AC)
Usage Category	AC 15	
Mechanical Life	Min Qty	1000000
Electrical Life	Min Qty	100000
Operating Frequency	On-Off/Hour	Mech. 120 Elec. 120
Insulation Voltage	Ui	660V
Impulse Withstand Voltage	Uimp	2.5 kV
Dielectric Strength (Body-Contact)	1.890V AC	
Dielectric Strength (Contact-Contact)	1.890V AC	
Isolation Resistance	10 MΩ Min. (500 V DC)	
Operating Temperature	-15 / + 80 °C	
Pollution Degree	3	
Protection Degree	IP67	
Contact Material	AgNi	
Cable Section	1.5-2.5 mm ²	
Screw Torque	1.5Nm	
Short Circuit Breaking Capacity	Ics	1kA
Serial	VT Series	
Speed	3 switch	
Cam	60°	
Specifications	High impact strength	
	V0 and Long Life Micro Switches	
Standards / Certificates	TS EN 60947-5-1	



Devre Şeması

