

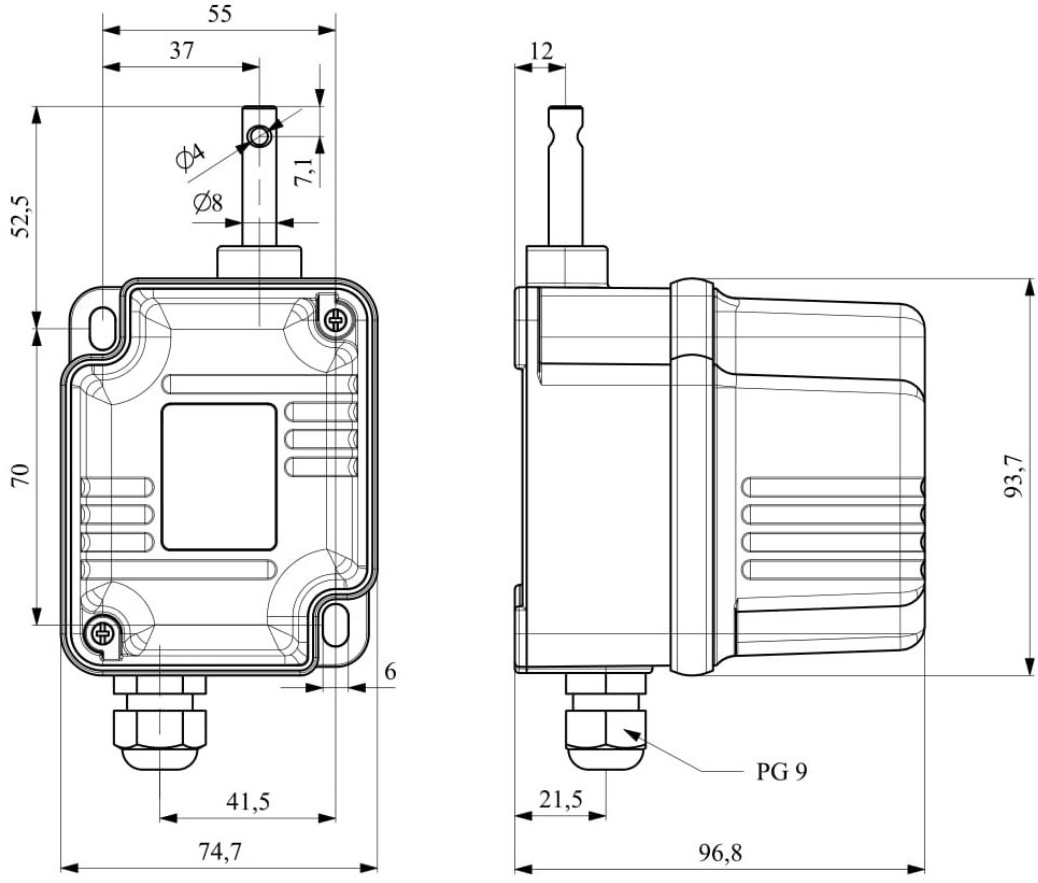

VT4150		
Product		Rotational Limit Switch
Type		1/150
Contact		4*CO
Current	Ie	10 A (250V AC)
Usage Category		AC 15
Mechanical Life	Min Qty	1000000
Electrical Life	Min Qty	100000
Operating Frequency	On-Off/Hour	Mech. 120 Elec. 120
Insulation Voltage	Ui	660V
Impulse Withstand Voltage	Uimp	2.5 kV
Dielectric Strength (Body-Contact)		1.890V AC
Dielectric Strength (Contact-Contact)		1.890V AC
Isolation Resistance		10 MΩ Min. (500 V DC)
Operating Temperature		-15 / + 80 °C
Pollution Degree		3
Protection Degree		IP67
Contact Material		AgNi
Cable Section		1.5-2.5 mm ²
Screw Torque		1.5Nm
Short Circuit Breaking Capacity	Ics	1kA
Serial		VT Series
Speed		4 switch
Cam		20°
Specifications		High impact strength
		V0 and Long Life Micro Switches
Standards / Certificates		TS EN 60947-5-1



Devre Şeması

