



### A54B1H10

Bağlantı Tipi		Terminalli
Baskı		(0-I) Baskılı
Ürün		Anahtar
Kontak		2NO
Renk		Siyah
Işık		Işıksız
Çap		30*22mm
Kontak Akımı	<b>Ie</b>	16 A (250V AC)
Kullanım Kategorisi		AC15
Mekanik Ömür	<b>Min Adet</b>	50000
Elektriksel Ömür	<b>Min Adet</b>	50000
Çalışma Sıklığı	<b>Açma Kapama/Saat</b>	Mek.900 Elk.900
Yalıtım Gerilimi	<b>Ui</b>	300 V
Darbe Dayanım Gerilimi	<b>Uimp</b>	2.5 kV
Dielektrik Mukavemeti (Gövde-Kontak)		2.500V AC
Dielektrik Mukavemeti (Kontak-Kontak)		1.500V AC
İzolasyon Direnci		10 MΩ min. (500V DC)
Çalışma Sıcaklığı		-15 / +80 °C
Kirlenme Derecesi		3
Koruma Sınıfı		IP65
Kontak Malzemesi		AgNi
Kablo Bağlantı Kesiti		Terminal 6,3*0,8 mm
Kısa devre kesme kapasitesi	<b>Ics</b>	1 kA
Seri		A54 Serisi
Gövde Rengi		Siyah Gövde
Özellikler		Işıklı veya Işıksız seçenek
		Dört farklı renk
		Siyah veya beyaz gövde seçeneği
		Ani hareketli

Standartlar / Belgeler

TS EN 61058-1



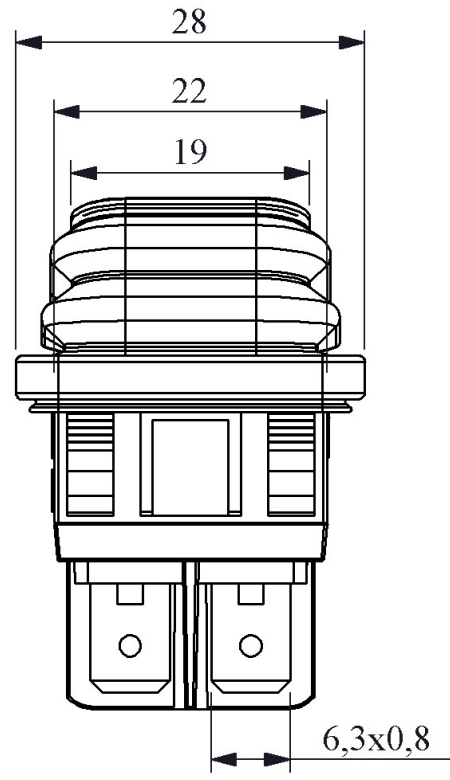
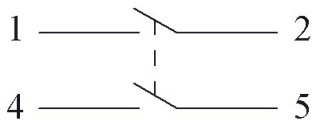
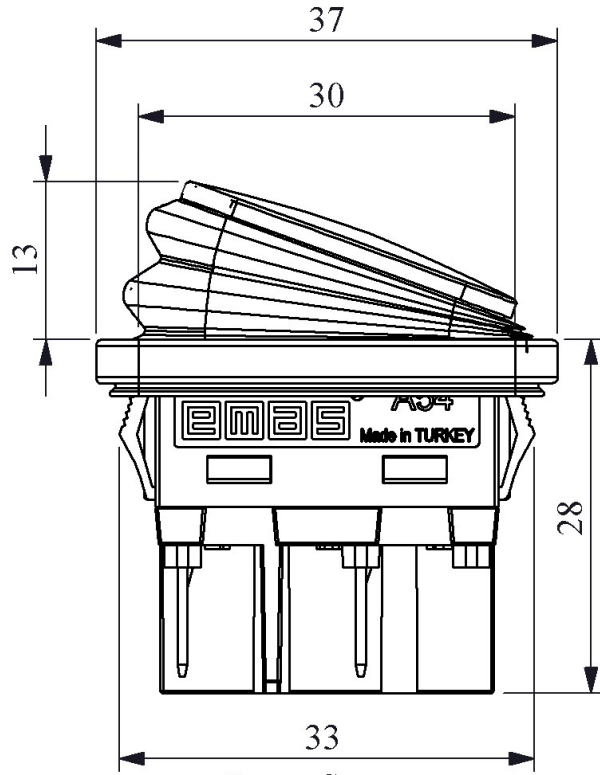

Montaj Ölçüsü 30,2x22,2mm