

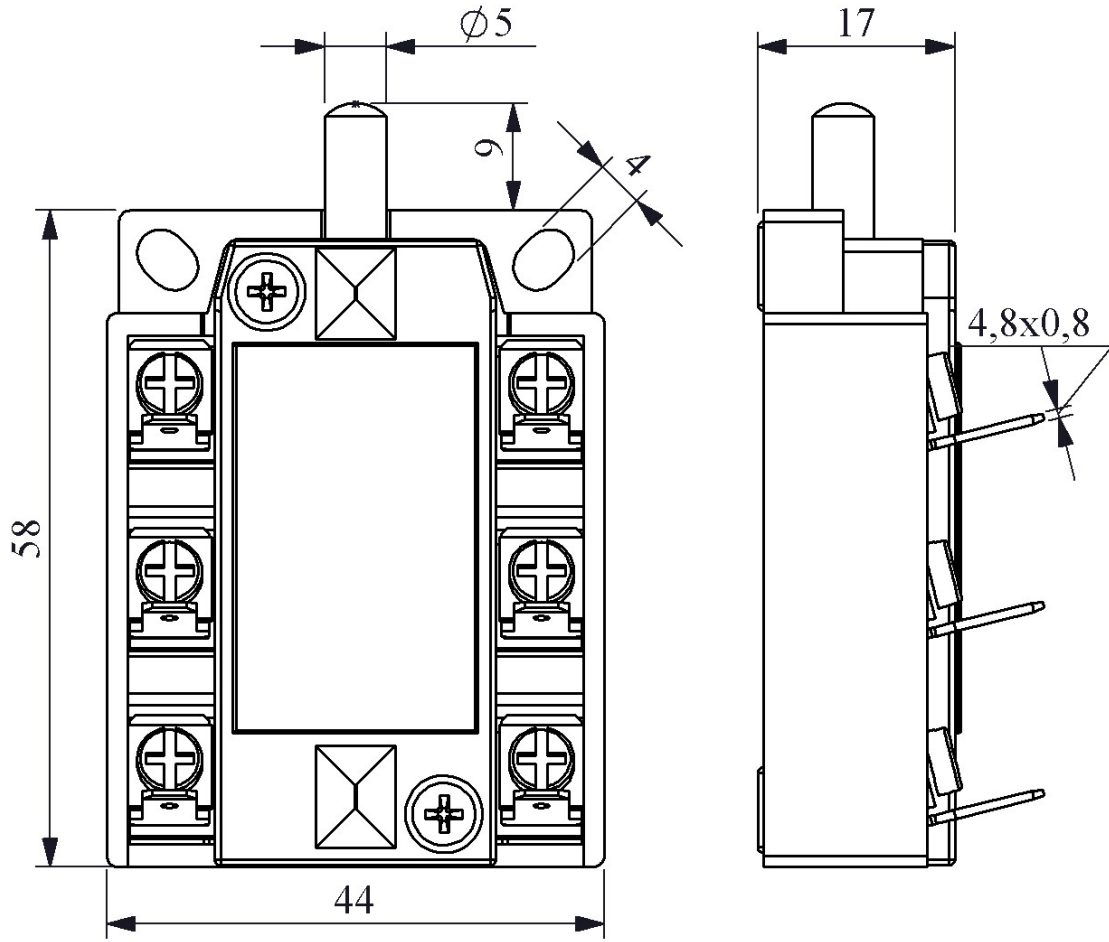

K25011T

Ürün	Hücre Switch
Seri	K Serisi
Kontak	2NO+1NC
Bağlantı Tipi	Terminalli
Kontak Akımı	I_e 2 A (250V AC)
Kullanım Kategorisi	AC15
Mekanik Ömür (Min Adet)	1000000
Elektriksel Ömür (Min Adet)	100000
Çalışma Sıklığı (Açma Kapama/Saat)	Mek. 3000 Elk. 1200
Yalıtım Gerilimi (U _i)	300 V
Darbe Dayanım Gerilimi (U _{imp})	2.5 kV
Dielektrik Mukavemeti (Gövde-Kontak)	2.500V AC
Dielektrik Mukavemeti (Kontak-Kontak)	1.500V AC
İzolasyon Direnci	10 MΩ min. (500V DC)
Çalışma Sıcaklığı	-25 / +80 °C
Kirlenme Derecesi	3
Koruma Sınıfı	IP20
Kontak Malzemesi	AgNi
Kablo Bağlantı Kesiti	Terminal 6,3*0,8 mm
Kısa devre kesme kapasitesi (I _{cs})	1 kA
Özellikler	V0 hammadde
Standartlar / Belgeler	TS EN 60947-5-1





Devre Şeması

