



### L51K13MEM124

Ürün	Sınır Şalter
Kontak	1NO+1NC
Duyar Blok	Ayarlanabilir Kollu Makara
Uç Elemanı Ölçüsü	18 mm
Kontak Akımı	<b>Ie</b> 3 A (240V AC)
Kullanım Kategorisi	AC15
Mekanik Ömür	<b>Min Adet</b> 10000000
Elektriksel Ömür	<b>Min Adet</b> 1000000
Çalışma Sıklığı	<b>Açma Kapama/Saat</b> Mek. 3000 Elk. 1800
Yalıtım Gerilimi	<b>Ui</b> 300 V
Darbe Dayanım Gerilimi	<b>Uimp</b> 2.5 kV
Dielektrik Mukavemeti (Gövde-Kontak)	1.890V AC
Dielektrik Mukavemeti (Kontak-Kontak)	1.890V AC
İzolasyon Direnci	10 MΩ (500 V DC)
Çalışma Sıcaklığı	-25 / + 80 °C
Kirlenme Derecesi	3
Koruma Sınıfı	IP65
Kontak Malzemesi	AgNi
Kablo Bağlantı Kesiti	1-2.5 mm <sup>2</sup>
Sıkma Kuvveti	1.5Nm
Kısa devre kesme kapasitesi	<b>Ics</b> 1 kA
İmal Tarihi	
Seri	L51 Metal Gövde
Kontak Hareketi	Ani Hareketli
Uç Elemanı Malzemesi	Metal
Özellikler	Prizmatik metal gövde ve kapaklı PG13,5 veya M20x1,5 kablo rakorlu Değişebilen kontak bloklu 1 kablo girişi

Baęlantı delikleri dıřarıda

Geniř duyar blok seęenekleri ile tm uygulamalara cevap verecek rn eř  
itlilięi

**Standartlar / Belgeler** TS EN 60947-5-1 UL 508 VDE 0660



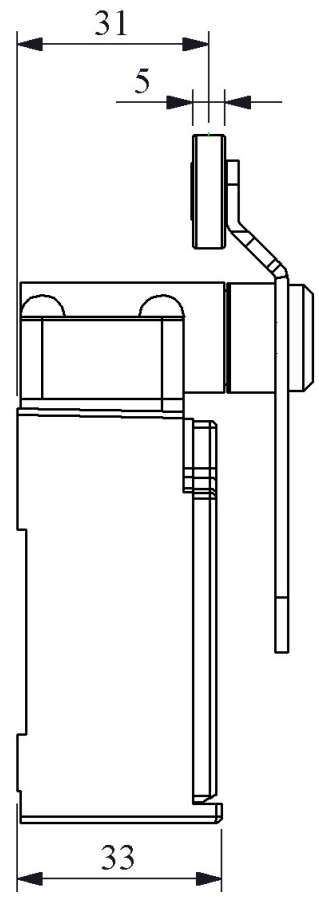
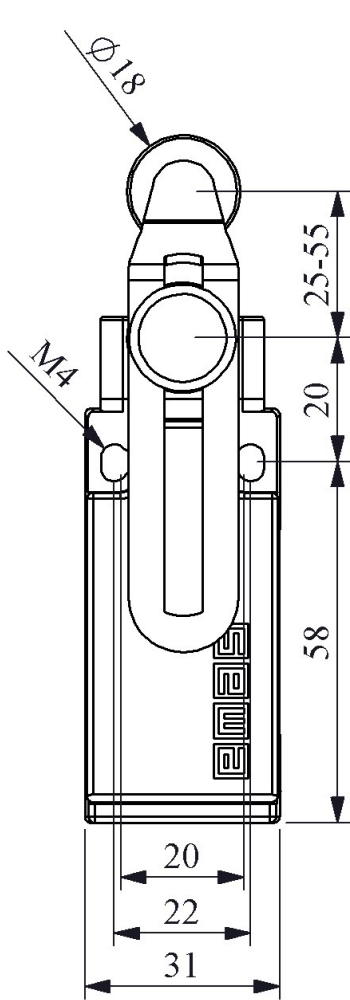

Devre Şeması

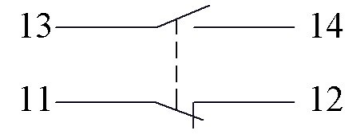

Ani Hareketli



Akış Diyagramı