



L52K13LEM621

Ürün	Sınır Şalter
Seri	L52 Metal Gövde
Uç Elemanı Malzemesi	Metal
Duyar Blok	Menteşe Emniyet Sivici
Kontak Hareketi	Ani Hareketli
Kontak	1NO+1NC
Kontak Akımı (Ie)	3 A (240V AC)
Kullanım Kategorisi	AC15
Mekanik Ömür (Min Adet)	10000000
Elektriksel Ömür (Min Adet)	1000000
Çalışma Sıklığı (Açma Kapama/Saat)	Mek. 3000 Elk. 1800
Yalıtım Gerilimi (Ui)	300 V
Darbe Dayanım Gerilimi (Uimp)	2.5 kV
Dielektrik Mukavemeti (Gövde-Kontak)	1.890V AC
Dielektrik Mukavemeti (Kontak-Kontak)	1.890V AC
İzolasyon Direnci	10 MΩ (500 V DC)
Çalışma Sıcaklığı	-25 / + 80 °C
Kirlenme Derecesi	3
Koruma Sınıfı	IP65
Kontak Malzemesi	AgNi
Kablo Bağlantı Kesiti	1-2.5 mm ²
Sıkma Kuvveti	1.5Nm
Kısa devre kesme kapasitesi (Ics)	1 kA
Özellikler	Metal gövde ve kapak 1 kablo girişi PG13,5 veya M20x1,5 opsiyonlu rakora uygun

Deđiřtirilebilen kontak blok

Farklı duyar blok seęenekleri

Standartlar / Belgeler

TS EN 60947-5-1 UL 508 VDE 0660



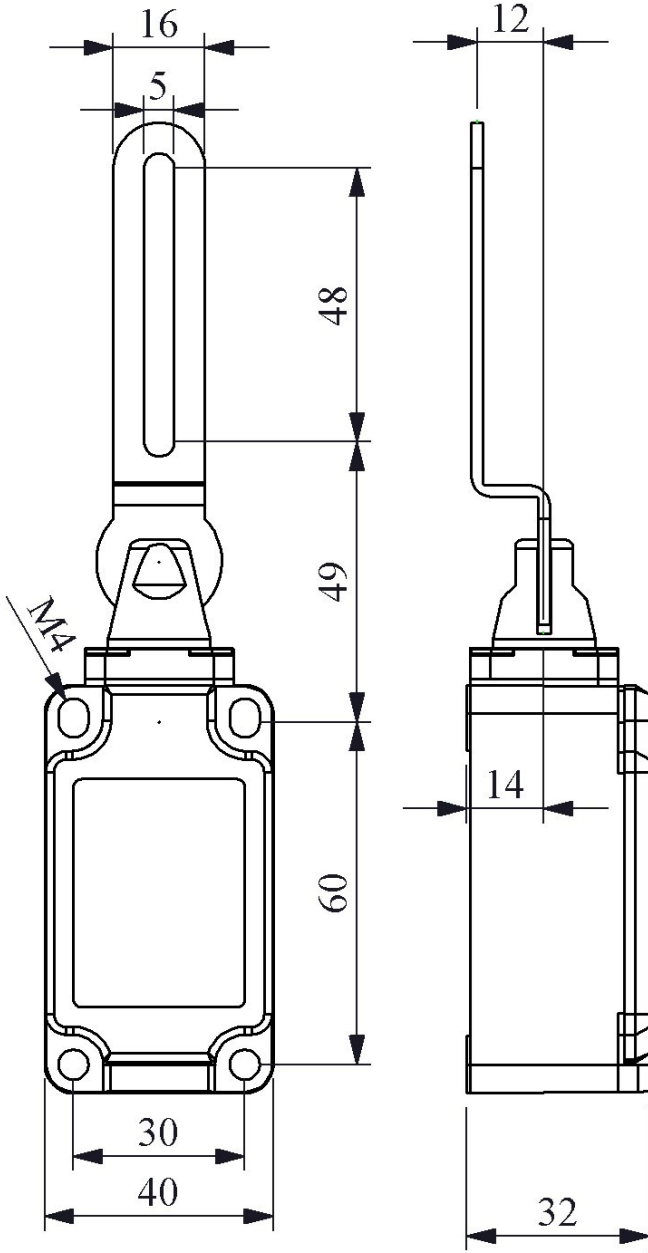

Devre Şeması

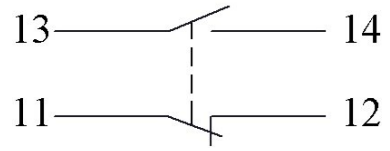

Ani Hareketli



Akış Diyagramı