

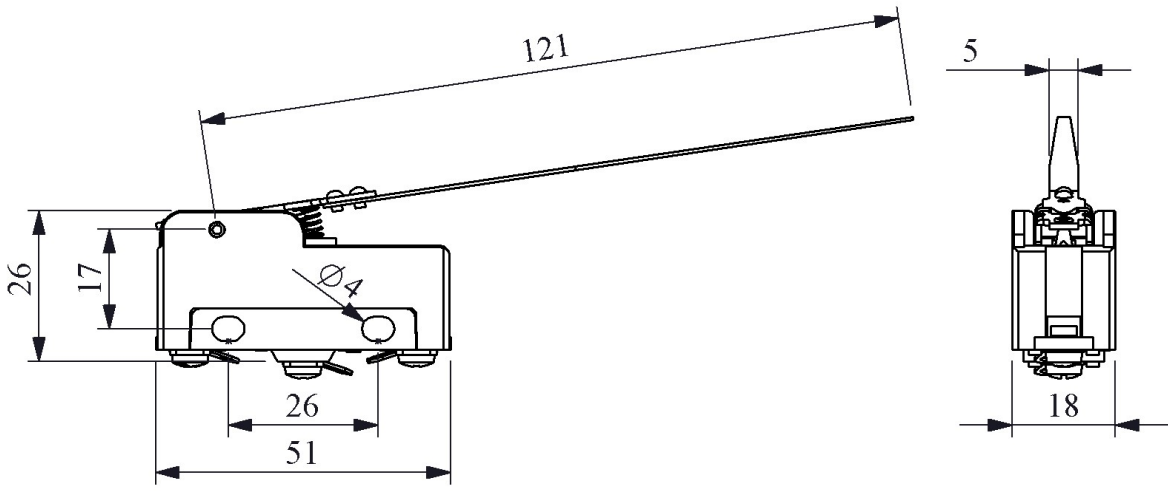

MN2KIM3

Ürün		Plastik Mini Switch
Kontak		1CO
Duyar Blok		Uzun Kollu
Kontak Akımı	Ie	6 A (250V AC)
Kullanım Kategorisi		AC15
Mekanik Ömür	Min Adet	500000
Elektriksel Ömür	Min Adet	100000
Çalışma Sıklığı	Açma Kapama/Saat	Mek. 3000 Elk. 1200
Yalıtım Gerilimi	Ui	660V
Darbe Dayanım Gerilimi	Uimp	2.5 kV
Dielektrik Mukavemeti (Gövde-Kontak)		1.890V AC
Dielektrik Mukavemeti (Kontak-Kontak)		1.890V AC
İzolasyon Direnci		10 MΩ min. (500V DC)
Çalışma Sıcaklığı		-25 / +80 °C
Kirlenme Derecesi		3
Koruma Sınıfı		IP20 (IP40 Koruma Kapaklı)
Kontak Malzemesi		AgNi
Kablo Bağlantı Kesiti		1-2.5 mm ²
Sıkma Kuvveti		1,5 Nm
Kısa devre kesme kapasitesi	Ics	1 kA
Seri		MN2 Serisi
Uç Elemanı Malzemesi		Metal
Özellikler		Geniş uygulama alanları için ürün çeşitliliği
		Uzun ömür
		Yüksek kontak güvenilirliği
		Standart montaj delikleri
Standartlar / Belgeler		TS EN 60947-5-1



Devre Şeması

